



RG60U Series

RG60U

RG60U-PCM

RG61U

RG61U-PCM

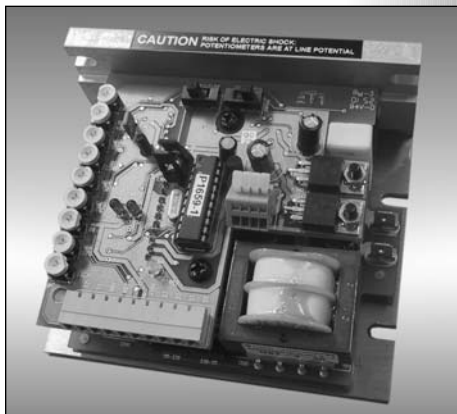

User's Manual

Dual Voltage, Adjustable Speed,
SCR Regenerative Drive for
Permanent Magnet DC Brush Motors

Copyright © 2009 by
Minarik Drives

All rights reserved. No part of this manual may be reproduced or transmitted in any form without written permission from Minarik Drives. The information and technical data in this manual are subject to change without notice. Minarik Drives makes no warranty of any kind with respect to this material, including, but not limited to, the implied warranties of its merchantability and fitness for a given purpose. Minarik Drives assumes no responsibility for any errors that may appear in this manual and makes no commitment to update or to keep current the information in this manual.

Printed in the United States of America.

Safety Warnings



SHOCK
HAZARD



AVOID
HEAT



KEEP
DRY



AVOID
VIBRATION

- This symbol  denotes an important safety tip or warning. **Please read these instructions carefully** before performing any of the procedures contained in this manual.
- **DO NOT INSTALL, REMOVE, OR REWIRE THIS EQUIPMENT WITH POWER APPLIED.** Have a qualified electrical technician install, adjust and service this equipment. Follow the National Electrical Code and all other applicable electrical and safety codes, including the provisions of the Occupational Safety and Health Act (OSHA), when installing equipment.
- Reduce the chance of an electrical fire, shock, or explosion by proper grounding, over-current protection, thermal protection, and enclosure. Follow sound maintenance procedures.



It is possible for a drive to run at full speed as a result of a component failure. Minarik strongly recommends the installation of a master switch in the main power input to stop the drive in an emergency.

Circuit potentials are at 115 VAC or 230 VAC above earth ground. Avoid direct contact with the printed circuit board or with circuit elements to prevent the risk of serious injury or fatality. Use a non-metallic screwdriver for adjusting the calibration trimpots. Use approved personal protective equipment and insulated tools if working on this drive with power applied.

Contents

Regenerative Drives	v
Specifications	1
Dimensions	2
Installation	4
Mounting	4
Wiring	5
Shielding guidelines	6
Heat sinking	7
Line fusing	7
Speed adjust potentiometer	9
Connections	10
Power, fuse and motor connections	11
Voltage follower (isolated signal)	16
Line voltage switches	17
Armature voltage switch	18
Feedback selector switch	18
Voltage or Current Follower (non-isolated signal, -PCM models) ..	19
Polarity reversal switch (-PCM models)	19
Operation	21
Before applying power:	21
Startup and shutdown	22
To start the drive:	22
Starting and Stopping Methods	23
Automatic restart upon power restoration	23
Decelerate to a stop	24
Coast to a stop	25
Regenerative brake	25
Invert Inhibit and Invert Enable	26

Calibration	30
MINIMUM SPEED (MIN SPD)	32
MAXIMUM SPEED (MAX SPD)	32
FORWARD TORQUE (FWD TQ)	33
REVERSE TORQUE (REV TQ)	34
IR COMPENSATION (IR COMP)	35
FORWARD ACCELERATION (FWD ACC)	36
REVERSE ACCELERATION (REV ACC)	36
DEADBAND (DB)	37
TACH GENERATOR (TACH)	38
MAX (RG60U-PCM isolation card)	40
OFFSET (RG60U-PCM isolation card)	41
Application Notes	42
Connections to Minarik DLC600	42
FWD-REV switch	43
FWD-STOP-REV switch	44
Independent Adjustable Speeds	45
Independent forward and reverse speeds	46
Independent forward and reverse speeds with FWD-STOP-REV switch	47
Troubleshooting	48
Before applying power	48
Replacement Parts	52
Unconditional Warranty	inside back cover

Tables

Table 1. Recommended Line Fuse Sizes	8
Table 2. Replacement Parts	52

Illustrations

Figure 1. Four Quadrant Operation	.vi
Figure 2. RG60U/RG61U Dimensions	2
Figure 3. RG60U-PCM/RG61U-PCM Dimensions	3
Figure 4. Speed Adjust Potentiometer	9
Figure 5. Screw Terminal Block	10
Figure 6. Cage-Clamp Terminal Block	10
Figure 7. Power and Motor Connections (Bottom Board)	13
Figure 8. Speed Adjust Potentiometer Connections	15
Figure 9. Voltage Follower Connection	16
Figure 10. Line Voltage Switches (bottom board)	17
Figure 11. Armature Voltage and Feedback Selector Switch Locations (top board)	18
Figure 12. RG-60U-PCM connections and jumper settings	20
Figure 13. RUN/STOP Switch	24
Figure 14. INHIBIT / ENABLE Terminal TB503 and JP502 Locations	27
Figure 15. INHIBIT Settings	28
Figure 16. ENABLE Settings	29
Figure 17. RG60U Calibration Trimpot Locations	31
Figure 18. Deadband Settings	37
Figure 19. Typical FWD TQ, REV TQ, and IR COMP Trimpot Settings	39
Figure 20. PCM Calibration Trimpot Locations	40
Figure 21. RG60U Connections to DLC600	42
Figure 22. Forward-Reverse Switch	43
Figure 23. Forward-Stop-Reverse Switch	44
Figure 24. Independent Adjustable Speeds (Forward Direction)	45
Figure 25. Independent Forward and Reverse Speeds	46
Figure 26. Independent Forward and Reverse Speeds with a Forward-Stop-Reverse Switch	47

Regenerative Drives

Most non-regenerative, variable speed, DC drives control current flow to a motor in one direction. The direction of current flow is the same direction as the motor rotation. Non-regenerative drives operate in Quadrant 1, and also in Quadrant 3 if the drive is reversible (see Figure 1, page VI). Motors must stop before reversing direction. Unless dynamic braking is used, non-regenerative drives cannot decelerate a load faster than coasting to a lower speed.

Regenerative drives operate in two additional quadrants: Quadrant 2 and Quadrant 4. In these quadrants, motor torque is in the opposite direction of motor rotation.

This allows regenerative drives to reverse a motor without contactors or switches, to control an overhauling load, and to decelerate a load faster than it would take to coast to a lower speed.

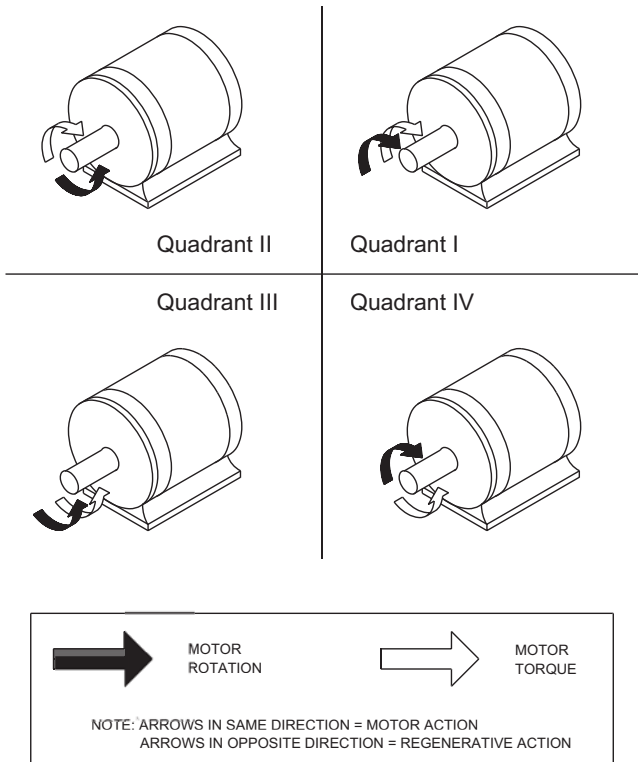

Figure 1. Four Quadrant Operation

Specifications

Model	Armature Current Range (ADC)	Armature Horsepower	Voltage Range (VDC)
RG60U, RG60U-PCM	5.0*	1/4 - 1/2*	0 - 90
	5.0**	1/4 - 1**	0 - 180
RG61U, RG61U-PCM	1.5	1/20 - 1/8	0 - 90
	1.5	1/10 - 1/4	0 - 180

* Max. Armature Current = 10 ADC and

Max. Horsepower = 1 hp when mounted to heat sink kit part number 223-0159.

** Max. Armature Current = 10 ADC and

Max. Horsepower = 2 hp when mounted to heat sink kit part number 223-0159.

AC Line Voltage	115 VAC / 230 VAC, $\pm 10\%$, 50/60 Hz, single phase
Form Factor	1.37 at base speed
Acceleration Time Range	0.5 – 6 seconds
Deceleration Time Range	0.5 – 6 seconds
Analog Input Voltage Range	
(without -PCM option, signal must be isolated; S0 to S2)	0 to +/- 10 VDC
Input Impedance (S0 to S2)	30 kohms
Load Regulation	
with Armature Feedback	1% base speed
with Tachogenerator Feedback	0.1% base speed
Vibration	0.5G max. (20–50 Hz) 0.1G max. (> 50 Hz)
Ambient Temperature Range	10°C – 55°C
Weight	1.1 lb

Dimensions

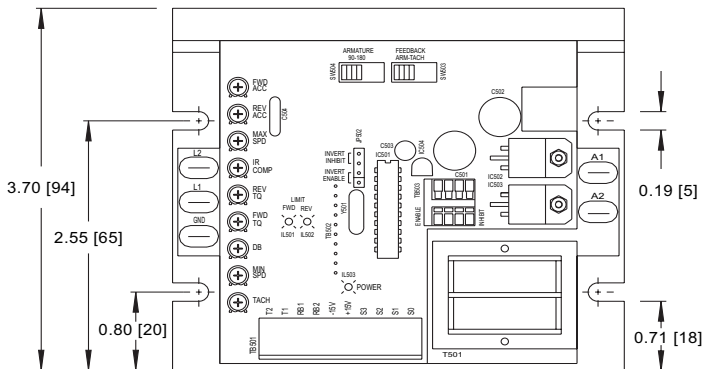

HEATSINK DIMENSIONS (optional)

6.9 x 4.4 x 1.0

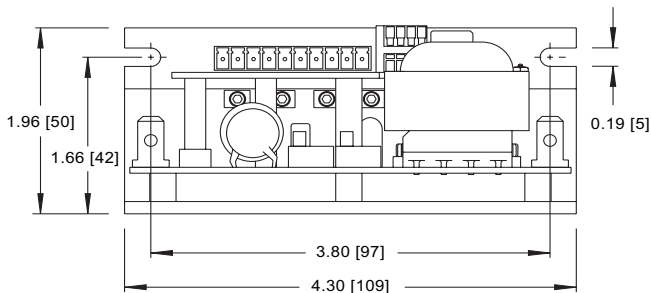

ALL DIMENSIONS IN INCHES [MILLIMETERS]

Figure 2. RG60U/RG61U Dimensions

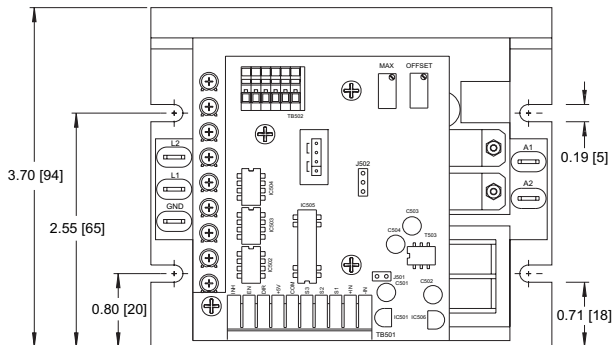

HEATSINK DIMENSIONS (optional)

6.9 x 4.4 x 1.0

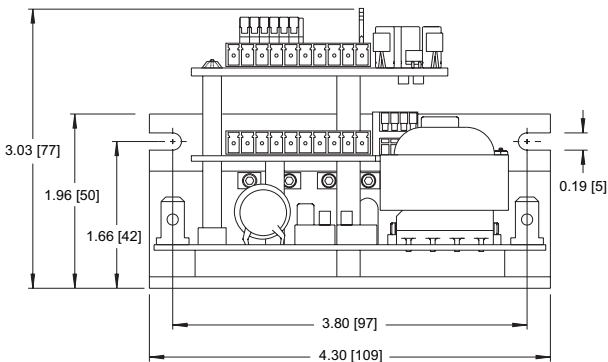

ALL DIMENSIONS IN INCHES [MILLIMETERS]

Figure 3. RG60U-PCM/RG61U-PCM Dimensions

Installation

Mounting



Warning

Do not install, rewire, or remove this control with input power applied. Doing so may cause fire or serious injury. Make sure you have read and understood the Safety Warnings on page i before attempting installation.

- Drive components are sensitive to electrostatic fields. Avoid direct contact with the circuit board. Hold drive by the chassis only.
- Protect the drive from dirt, moisture, and accidental contact.
- Provide sufficient room for access to the terminal block and calibration trimpots.
- Mount the drive away from heat sources. Operate the drive within the specified ambient operating temperature range.
- Prevent loose connections by avoiding excessive vibration of the drive.
- Mount drive with its board in either a horizontal or vertical plane. Six 0.19 in. (5 mm) wide slots in the chassis accept #8 pan head screws. Fasten either the large base or the narrow flange of the chassis to the subplate.
- The chassis should be earth grounded. Use a star washer beneath the head of at least one of the mounting screws to penetrate the anodized chassis surface and to reach bare metal.

Wiring



Warning



Do not install, rewire, or remove this control with input power applied. Failure to heed this warning may result in fire, explosion, or serious injury.

Circuit potentials are at 115 or 230 VAC above ground. To prevent the risk of injury or fatality, avoid direct contact with the printed circuit board or with circuit elements.

Do not disconnect any of the motor leads from the drive unless power is removed or the drive is disabled. Opening any one motor lead while the drive is running may destroy the drive.

- Use 18 AWG wire for speed adjust potentiometer wiring. Use 14 AWG wire for AC line (L1, L2) and motor (A1, A2) wiring.

Shielding guidelines



Warning

Under no circumstances should power and logic leads be bundled together. Induced voltage can cause unpredictable behavior in any electronic device, including motor controls.

As a general rule, Minarik recommends shielding of all conductors.

If it is not practical to shield power conductors, Minarik recommends shielding all logic-level leads. If shielding of all logic-level leads is not practical, the user should twist all logic leads with themselves to minimize induced noise.

It may be necessary to earth ground the shielded cable. If noise is produced by devices other than the drive, ground the shield at the drive end. If noise is generated by a device on the drive, ground the shield at the end away from the drive. Do not ground both ends of the shield.

If the drive continues to pick up noise after grounding the shield, it may be necessary to add AC line filtering devices, or to mount the drive in a less noisy environment.

Logic wires from other input devices, such as motion controllers and PLL velocity controllers, must be separated from power lines in the same manner as the logic I/O on this drive.

Heat sinking

The RG60U drive requires an additional heat sink when the continuous armature current is above 5 ADC. Use Minarik heat sink kit part number 223-0159. Use a thermally conductive heat sink compound (such as Dow Corning® 340 Heat Sink compound) between the drive chassis and the heat sink surface for optimum heat transfer.

Line fusing

Minarik drives should be used with fuses for protection. Use fast acting fuses rated for 250 VAC or higher. Fuse L1 only when the line voltage is 115 VAC. Fuse both L1 and L2 when the line voltage is 230 VAC.

Table 1 on page 8 lists the recommended line fuse sizes.

Table 1. Recommended Line Fuse Sizes

90 VDC Motor Horsepower	180 VDC Motor Horsepower	Max. DC Armature Current (amps)	AC Line Fuse Size (amps)
1/20	1/10	0.5	3
1/15	1/8	0.8	3
1/8	1/4	1.5	5
1/6	1/3	1.75	5
1/4	1/2	2.5	8
1/3	3/4	3.5	8
1/2	1	5.0	10
3/4	1 1/2	7.5	15
1	2	10	20

Minarik Corporation offers two fuse kits: part number 050-0069 (3-8A Fuse Kit) and 050-0073 (5-20A Fuse Kit).

Speed adjust potentiometer



Warning

Be sure that the potentiometer tabs do not make contact with the potentiometer enclosure. Grounding the input will cause damage to the drive.

Mount the speed adjust potentiometer through a 0.38 in. (10 mm) hole with the hardware provided (Figure 4). Install the circular insulating disk between the panel and the 10K ohm speed adjust potentiometer.

Twist the speed adjust potentiometer wire to avoid picking up unwanted electrical noise. If speed adjust potentiometer wires are longer than 18 in. (46 cm), use shielded cable. Keep speed adjust potentiometer wires separate from power leads (L1, L2, A1, A2).

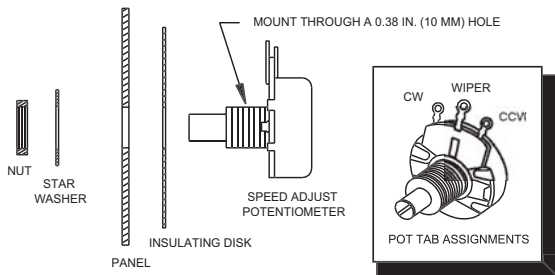

Figure 4. Speed Adjust Potentiometer

Connections

Screw terminal block

Most connections to the RG60U drive are made to a screw terminal block (part number 160-0171). Using a screwdriver, turn the terminal block screw counterclockwise to open the wire clamp. Insert 18 AWG stripped wire into the wire clamp. Turn the terminal block screw clockwise to clamp the wire.

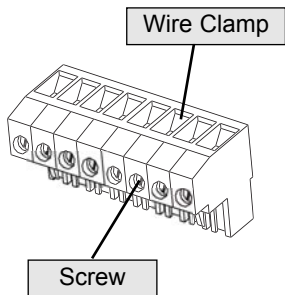

Figure 5. Screw Terminal Block

Cage-clamp terminal block

Inhibit and enable connections are made to a cage-clamp terminal block. To insert a wire into the terminal block, press down on the lever arm using a small screwdriver. Insert 20 AWG stripped wire into the wire clamp in front of the terminal block. Release the lever arm to clamp the wire.

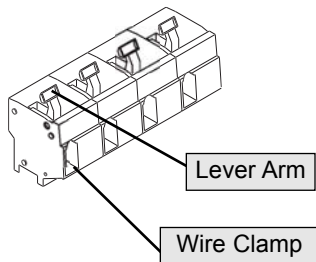

Figure 6. Cage-Clamp Terminal Block



Warning

Do not connect this equipment with power applied. Failure to heed this directive may result in fire or serious injury.

Minarik strongly recommends the installation of a master power switch in the voltage input line, as shown in Figure 7, page 13. The switch contacts should be rated at a minimum of 200% of motor nameplate current and 250 volts.

Power, fuse and motor connections

Connect the power input leads, an external line fuse and a DC motor to the drive's printed circuit board (PCB) as shown in Figure 7, page 13.

Motor

Minarik drives supply motor voltage from A1 and A2 terminals. It is assumed throughout this manual that, when A1 is positive with respect to A2, the motor will rotate clockwise (CW) while looking at the output shaft protruding from the front of the motor. If this is opposite of the desired rotation, simply reverse the wiring of A1 and A2 with each other (A1 - and A2 +).

Connect a DC motor to PCB terminals A1 and A2 as shown in Figure 7, page 13. **Ensure that the motor voltage rating is consistent with the drive's output voltage.**

Power input

Connect the AC line power leads to terminals L1 and L2, or to a double-throw, single-pole master power switch (recommended).

Line fuse

Wire an external line fuse between the stop switch (if installed) and the terminal board (Figure 7, page 13). An additional line fuse should be installed on L2 if the input voltage is 230 VAC. Refer to the line fuse table (Table 1 on page 8) for fuse ratings.

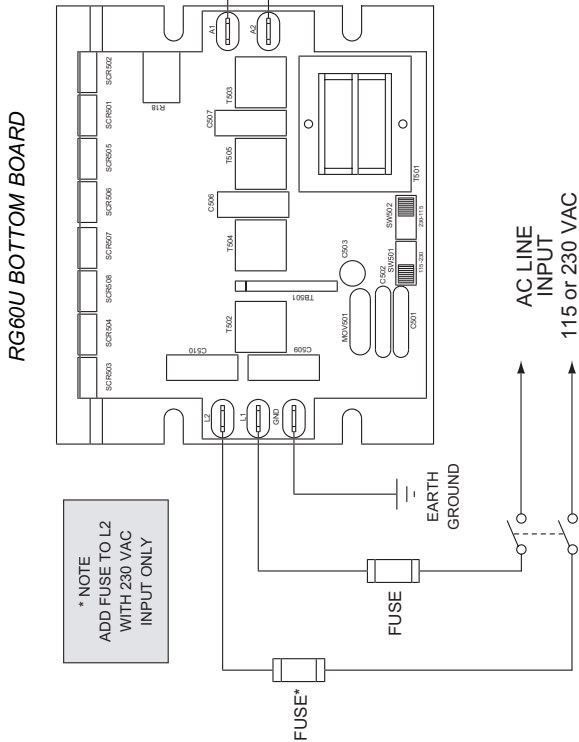

Figure 7. Power and Motor Connections (Bottom Board)

Speed adjust potentiometer connections

The motor can operate in one direction (unidirectional) or two directions (bidirectional) depending on how the speed adjust potentiometer is connected to the drive.

Connect the speed adjust potentiometer as shown in Figure 8(a), page 15 for bidirectional operation. The motor does not operate when the wiper is in the center position. Turning the wiper clockwise (CW) from the center position causes the motor to rotate in one direction, while turning the wiper counterclockwise (CCW) causes rotation in the opposite direction.

Connect the speed adjust potentiometer as shown in Figure 8(b), page 15 for unidirectional operation in the forward direction.

Connect the speed adjust potentiometer as shown in Figure 8(c), page 15 for unidirectional operation in the reverse direction.

Refer to the Application Notes section for additional speed adjust potentiometer connections.

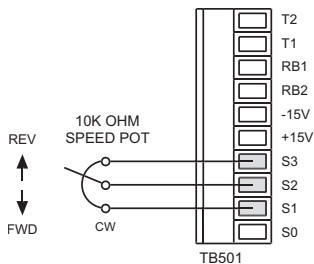

(a) Bidirectional Operation

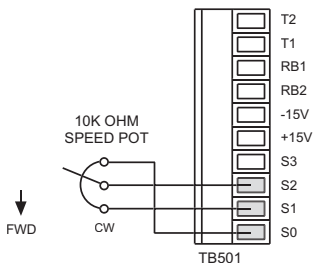

(b) Unidirectional Operation,
Forward Direction

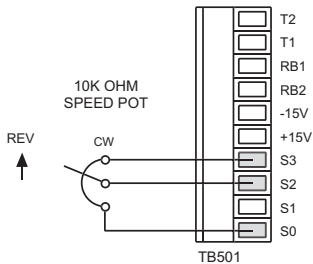

(c) Unidirectional Operation,
Reverse Direction

Figure 8. Speed Adjust Potentiometer Connections

Voltage follower (isolated signal)

The drive may be wired to follow a floating (isolated) 0 to ± 10 VDC signal that is isolated from earth ground instead of using a speed adjust potentiometer. Connect the signal input to S2, and the signal common to S0 (see Figure 9).

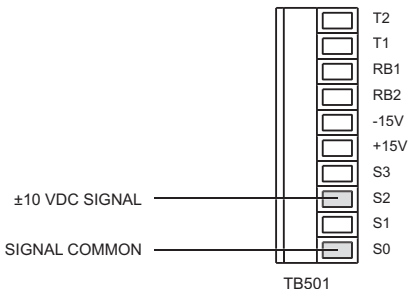

Figure 9. Voltage Follower Connection

NOTE: For configuration of a non-isolated voltage or current signal, please refer to the -PCM option (page 19).

Line voltage switches

SW501 and SW502 on the bottom board are the line voltage switches (see Figure 10). Set the switches to 115 VAC if the line voltage is 115 VAC, or to 230 VAC if the line voltage is 230 VAC.

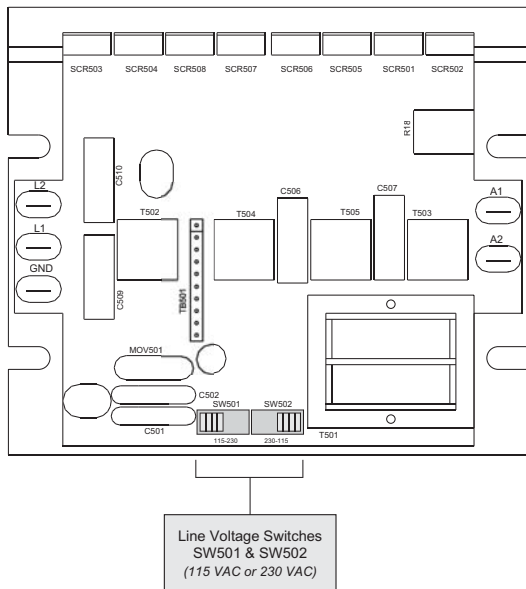

Figure 10. Line Voltage Switches (bottom board)

Armature voltage switch

SW504 on the top board is the armature voltage selector switch. Set SW504 to 90 if using a 90 VDC motor, or to 180 if using a 180 VDC motor. See Figure 11 for SW504 location.

Feedback selector switch

SW503 on the top board is the feedback selector switch. Set SW503 to TACH if using a tachogenerator; otherwise, set it to ARM for armature feedback. See Figure 11 for SW503 location.

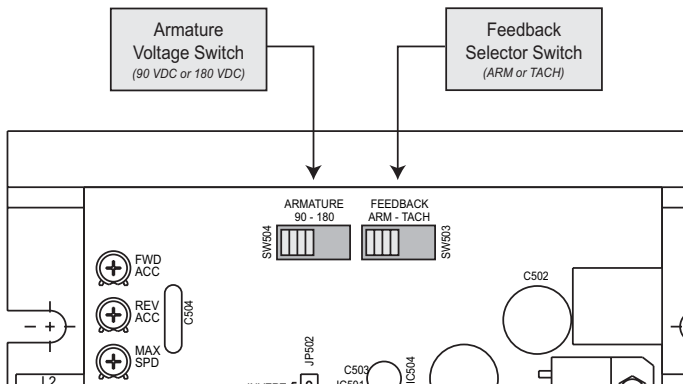

Figure 11. Armature Voltage and Feedback Selector Switch Locations (top board)

Voltage or Current Follower (non-isolated signal, -PCM models)

PCM series drives can be configured to follow a grounded (non-isolated) voltage or current signal. To configure the drive to follow a voltage or current signal, connect the signal leads to the +IN and -IN terminals on TB501, observing proper polarity. Ensure that the following jumper terminals are properly set:

J501 Settings

Open pins 1 & 2 for -10 to +10 VDC signal or pot input.

Jumper pins 1 & 2 for 4 to 20 mA signal input.

J502 Settings

Jumper pins 2 & 3 for -10 to +10 VDC signal or pot input.

Jumper pins 1 & 2 for 4 to 20 mA signal input.

See Figure 12, page 20 for jumper and terminal locations.

Polarity reversal switch (-PCM models)

To reverse the output voltage polarity without changing the input polarity, connect the DIR terminal to the +5V terminal on TB501 of the PCM board. A single-pole, single-throw switch can be used as a polarity reversal switch. Close the switch to reverse the output voltage polarity. Open the switch to return the output voltage back to its original polarity. See Figure 12, page 20 for polarity reversal switch connections.

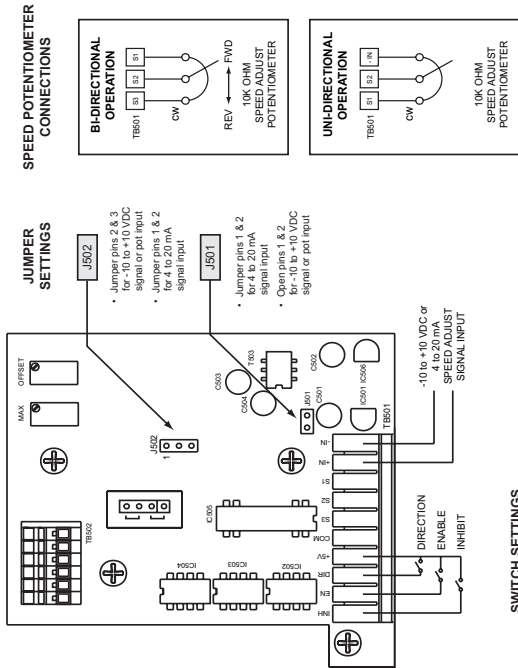
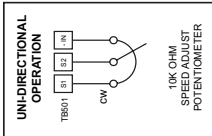
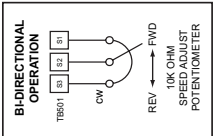

Figure 12. RG-60U-PCM connections and jumper settings

SPEED POTENTIOMETER CONNECTIONS



Operation

**Warning**

Dangerous voltages exist on the drive when it is powered. BE ALERT. High voltages can cause serious or fatal injury. For your safety, use personal protective equipment (PPE) when operating this drive.

Before applying power:

1. Verify that no conductive material is present on the printed circuit board.
2. Ensure that all switches and jumpers are properly set.

Startup and shutdown

To start the drive:

1. Set the speed adjust potentiometer or reference voltage to zero speed.
2. Apply AC line voltage.
3. Slowly turn the speed adjust potentiometer clockwise or counterclockwise to rotate the motor in the forward or reverse direction. If in a voltage follower mode, slowly increase the voltage in either the positive or negative direction to rotate the motor in the forward or reverse direction. Continue until the desired speed is reached.
4. To decelerate the motor from set speed to a stop, reset the speed adjust potentiometer to zero speed, or reference voltage to zero. To coast the motor from set speed to a stop, remove AC line voltage from the drive .

If the motor or drive does not perform as described, disconnect the AC line voltage immediately. Refer to the Troubleshooting section for further assistance.

Starting and Stopping Methods



Warning

Decelerating to minimum speed, regenerative braking, or coasting to a stop is recommended for frequent starts and stops. Do not use any of these methods for emergency stopping. They may not stop a drive that is malfunctioning. Removing AC line power (both L1 and L2) is the only acceptable method for emergency stopping.

For this reason, Minarik strongly recommends installing an emergency stop switch on both the L1 and L2 inputs (see Figure 7, page 13).

Frequent decelerating to minimum speed or regenerative braking produces high torque. This may cause damage to motors, especially gearmotors that are not properly sized for the application

Automatic restart upon power restoration

All drives automatically run to set speed when power is applied and enabled.

Decelerate to a stop

The RUN/STOP switch in Figure 13 may be used to decelerate a motor to a stop. Closing the switch between RB1 and RB2 decelerates the motor from set speed to a stop. The FWD ACC and REV ACC trimpot settings determine the rate at which the will drive decelerate to a stop and accelerate back to set speed. Set the switch to the RUN position to accelerate the motor to set speed.

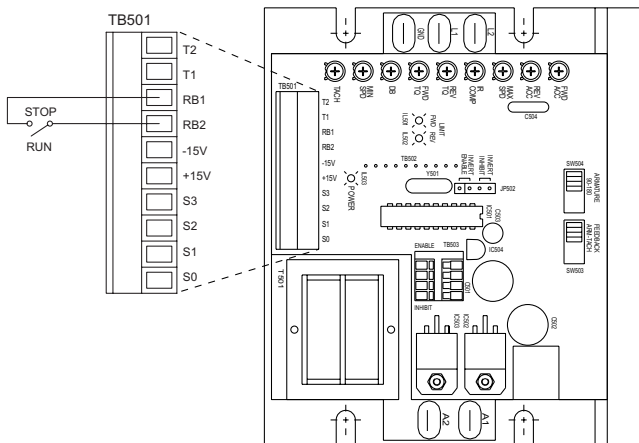

Figure 13. RUN/STOP Switch

Regenerative brake

To regeneratively brake the motor, short the INHIBIT terminals on TB503. Reopening the INHIBIT terminals causes the motor to accelerate to set speed (see Figure 14, page 27 for INHIBIT terminal locations and Figure 15, page 28 for INHIBIT settings).

Twist inhibit wires and separate them from other power-carrying wires or sources of electrical noise. Use shielded cable if the inhibit wires are longer than 18 in. (46 cm). If shielded cable is used, ground only one end of the shield to earth ground. Do not ground both ends of the shield.

Coast to a stop

To coast the motor to a stop without removing power to the drive, short the ENABLE terminals on TB503 (see Figure 14, page 27 for ENABLE terminal locations and Figure 16, page 29 for ENABLE settings).

Momentarily shorting the ENABLE terminals will coast the motor to zero speed, then accelerate back to set speed.

Completely shorting the ENABLE terminals will coast the motor to a complete stop. Reopening the ENABLE terminals causes the motor to accelerate to set speed.

Invert Inhibit and Invert Enable

INVERT modes reverse the function of the INHIBIT and ENABLE terminals. Each drive is assembled with the INVERT INHIBIT and INVERT ENABLE jumper settings open (jumpers on location 1 and 4 of JP502). See Figure 14, page 27 for JP502 location.

To activate the INVERT INHIBIT mode, jumper locations 1 and 2 of JP502 (see Figure 15, page 28). In INVERT INHIBIT mode, the motor will regeneratively brake when inhibit terminals are open. To accelerate the motor to set speed, close the inhibit terminals.

To activate the INVERT ENABLE mode, jumper locations 3 and 4, (see Figure 16, page 29). In INVERT ENABLE mode, the motor will coast to a stop when the enable terminals are open. To accelerate the motor to set speed, close the enable terminals.

**INVERT INHIBIT & INVERT ENABLE
Jumper Settings (JP502)**

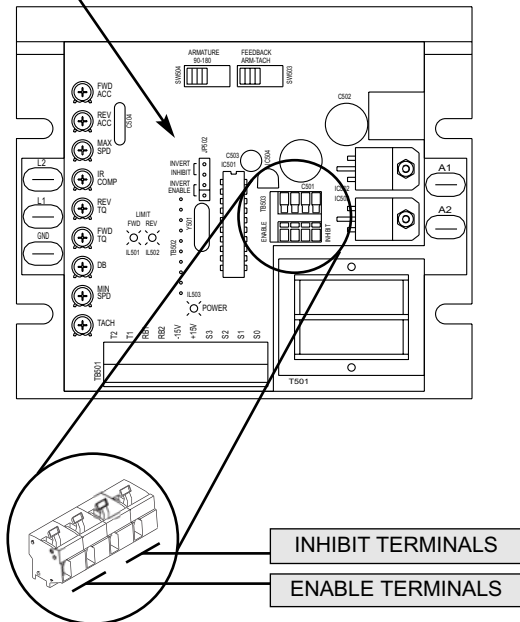
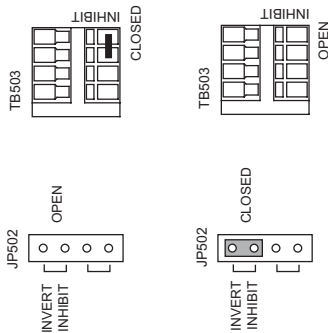

Figure 14. INHIBIT / ENABLE Terminal TB503 and JP502 Locations

I N H I B I T S E T T I N G S

CONFIGURATION



DRIVE RESPONSE

INHIBIT MODE

MOTOR REGENERATIVELY BRAKES
WHEN INHIBIT
TERMINALS ARE CLOSED

INVERT INHIBIT MODE

MOTOR REGENERATIVELY BRAKES
WHEN INHIBIT TERMINALS
ARE OPENED

NOTE: The RG60U will operate in normal running mode when all jumpers on JP502 and all terminals on TB503 are simultaneously opened. Likewise, it will operate in normal running mode when all jumpers and terminals are simultaneously closed.

Figure 15. INHIBIT Settings

ENABLE SETTINGS

CONFIGURATION

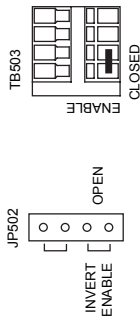

DRIVE RESPONSE



MAINTAINED CLOSED
MOTOR COASTS
TO STOP WHEN
ENABLE TERMINALS
ARE MAINTAINED
CLOSED

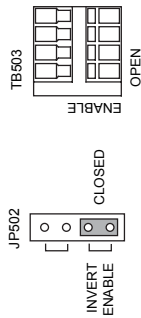

MAINTAINED OPEN
MOTOR COASTS
TO STOP WHEN
ENABLE TERMINALS
ARE MAINTAINED
OPEN

NOTE: The RG60U will operate in normal running mode when all jumpers on JP502 and all terminals on TB503 are simultaneously opened. Likewise, it will operate in normal running mode when all jumpers and terminals are simultaneously closed.

Figure 16. ENABLE Settings

Calibration



Warning

Dangerous voltages exist on the drive when it is powered. When possible, disconnect the voltage input from the drive before adjusting the trimpots. If the trimpots must be adjusted with power applied, use insulated tools and the appropriate personal protection equipment. BE ALERT. High voltages can cause serious or fatal injury.

The RG60U has nine user adjustable trimpots: FWD ACC, REV ACC, MAX SPD, IR COMP, REV TQ, FWD TQ, DB, MIN SPD, and TACH. Each drive is factory calibrated to its maximum current rating. Readjust the calibration trimpot settings to accommodate lower current rated motors.

All adjustments increase with clockwise rotation, (CW) and decrease with counterclockwise (CCW) rotation. Use a non-metallic screwdriver for calibration. Each trimpot is identified on the printed circuit board. See Figure 17, page 31 for RG60U calibration trimpot locations.

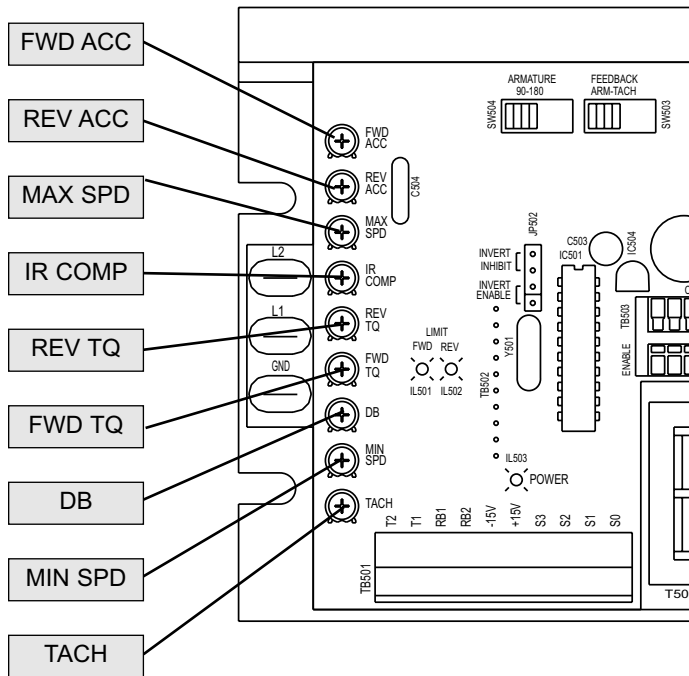

Figure 17. RG60U Calibration Trimpot Locations

MINIMUM SPEED (MIN SPD)

The MIN SPD trimpot setting determines the minimum speed when the speed adjust potentiometer is turned full CCW. It is factory set to zero speed. The minimum speed feature applies only when the drive is operating in unidirectional mode.

To calibrate MIN SPD:

1. Set the speed adjust potentiometer to full CCW.
2. Adjust the MIN SPD trimpot until the desired minimum motor speed is reached.

MAXIMUM SPEED (MAX SPD)

The MAX SPD trimpot setting determines the maximum forward and reverse speed. It is factory set for maximum rated motor speed.

To calibrate MAX SPD:

1. Set the MAX SPD trimpot full CCW.
2. Turn the speed adjust potentiometer CW so that the motor is running at full speed.
3. Adjust the MAX SPD trimpot until the desired maximum motor speed is reached.

Caution! Do not attempt to run motor above 90 VDC on 115 VAC or above 180 VDC on 230 VAC.

FORWARD TORQUE (FWD TQ)



Warning

Although FWD TQ can be set to 120% of motor nameplate current rating, continuous operation beyond this rating may damage the motor. If you intend to operate beyond this rating, contact your Minarik representative for assistance.

The FWD TQ setting determines the maximum current limit for accelerating and driving the motor in the forward direction. It is factory set at 120% of maximum rated drive current.

See Figure 19 (page 39) for typical FWD TQ calibration settings or use the following procedure to recalibrate FWD TQ:

1. With the power disconnected from the drive, connect a DC ammeter in series with the armature.
2. Set the FWD TQ trimpot to minimum (full CCW).
3. Set the speed adjust potentiometer to maximum (full CW).
4. Carefully lock the motor armature. Be sure that the motor is firmly mounted.
5. Apply line power. The motor should be stopped.
6. Slowly adjust the FWD TQ trimpot CW slowly until the armature current is 120% of motor rated armature current.
7. Set the speed adjust potentiometer to minimum.
8. Remove the power from the drive.
9. Unlock the motor shaft.
10. Remove the ammeter in series with the motor armature if it is no longer needed and re-apply power to the drive.

REVERSE TORQUE (REV TQ)



Warning

Although REV TQ can be set to 120% of motor nameplate current rating, continuous operation beyond this rating may damage the motor. If you intend to operate beyond this rating, contact your Minarik representative for assistance.

The REV TQ setting determines the maximum current limit for accelerating and driving the motor in the reverse direction. It is factory set at 120% of maximum rated drive current.

See Figure 19 (page 39) for typical REV TQ calibration settings or use the following procedure to recalibrate REV TQ:

1. With the power disconnected from the drive, connect a DC ammeter in series with the armature.
2. Set the REV TQ trimpot to minimum (full CCW).
3. Set the speed adjust potentiometer to maximum (full CW).
4. Carefully lock the motor armature. Be sure that the motor is firmly mounted.
5. Apply line power. The motor should be stopped.
6. Slowly adjust the REV TQ trimpot CW slowly until the armature current is 120% of motor rated armature current.
7. Set the speed adjust potentiometer to minimum.
8. Remove the power from the drive.
9. Unlock the motor shaft.
10. Remove the ammeter in series with the motor armature if it is no longer needed and re-apply power to the drive.

IR COMPENSATION (IR COMP)

The IR COMP trimpot setting determines the degree to which motor speed is held constant as the motor load changes. It is factory set for optimum motor regulation.

See Figure 19 (page 39) for typical IR COMP calibration settings or use the following procedure to recalibrate the IR COMP setting:

1. Set the IR COMP trimpot to minimum (full CCW).
2. Rotate the speed adjust potentiometer until the motor runs at mid-speed without load (for example, 900 RPM for an 1800 RPM motor). A hand held tachometer may be used to measure motor speed.
3. Load the motor armature to its full load armature current rating. The motor should slow down.
4. While keeping the load on the motor, rotate the IR COMP trimpot until the motor runs at the speed measured in step 2. If the motor oscillates (overcompensation), the IR COMP trimpot may be set too high (CW). Turn the IR COMP trimpot CCW to stabilize the motor.
5. Unload the motor.

FORWARD ACCELERATION (FWD ACC)

The FWD ACC setting determines the time the motor takes to ramp to either a higher speed in the forward direction or a lower speed in the reverse direction, within the limits of available torque. The FWD ACC setting is factory set for its fastest forward acceleration time.

Turn the FWD ACC trimpot CW to increase the forward acceleration time, and CCW to decrease the forward acceleration time.

REVERSE ACCELERATION (REV ACC)

The REV ACC setting determines the time the motor takes to ramp to either a higher speed in the reverse direction or a lower speed in the forward direction, within the limits of available torque. The REV ACC setting is factory set for its fastest reverse acceleration time.

Turn the REV ACC trimpot CW to increase the reverse acceleration time, and CCW to decrease the reverse acceleration time.

DEADBAND (DB)

The deadband trimmer potentiometer determines the time that will elapse between the application of current in one direction before current is applied in the opposite direction.

The deadband trimmer potentiometer affects the resistance that a motor has to changes in shaft position at zero speed. It does this by applying AC voltage to the motor armature.

Deadband is factory calibrated with the notch at approximately the 3 o'clock position for 60 Hz AC line operation. Recalibrate the deadband with the notch at the 9 o'clock position for 50 Hz AC line operation. If you hear motor noise (humming), the deadband might be set too high. Turn the deadband trimpot CCW until the motor noise ceases.

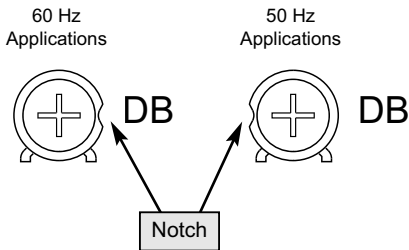

Figure 18. Deadband Settings

TACH GENERATOR (TACH)

Calibrate the TACH setting only when a tachogenerator is used. The TACH setting, like the IR COMP setting, determines the degree to which motor speed is held constant as the motor load changes.

To calibrate the TACH trimpot:

1. Connect the tachogenerator to T1 and T2. The polarity is positive (+) for T1 and negative (-) for T2 with the motor running in forward direction.
2. Set SW503 to ARM for armature feedback.
3. Set the speed adjust potentiometer full CW. Measure the armature voltage across A1 and A2 using a voltmeter.
4. Set the speed adjust potentiometer to 0 (zero speed).
5. Set SW503 to TACH for tachogenerator feedback.
6. Set the IR COMP trimpot to full CCW.
7. Set the TACH trimpot to full CW.
8. Apply line power.
9. Set the speed adjust potentiometer to full CW.
10. Adjust the TACH trimpot until the armature voltage is the same value as the voltage measured in step 3.

Check that the tachogenerator is properly calibrated. The motor should run at the same speed when SW503 is set to either armature or tachogenerator feedback.

























			1 HP 90 VDC 10 ADC				2 HP 180 VDC 9.2 ADC
FWD TQ	REV TQ	IR COMP		FWD TQ	REV TQ	IR COMP	
			3/4 HP 90 VDC 7.6 ADC				1 HP 180 VDC 5 ADC
FWD TQ	REV TQ	IR COMP		FWD TQ	REV TQ	IR COMP	
			1/2 HP 90 VDC 5 ADC				3/4 HP 180 VDC 3.8 ADC
FWD TQ	REV TQ	IR COMP		FWD TQ	REV TQ	IR COMP	
			1/4 HP 90 VDC 2.7 ADC				1/2 HP 180 VDC 2.5 ADC
FWD TQ	REV TQ	IR COMP		FWD TQ	REV TQ	IR COMP	

Figure 19. Typical FWD TQ, REV TQ, and IR COMP Trimpot Settings

MAX (-PCM isolation card)

Determines the motor speed when the speed adjust potentiometer is turned to full CW, or voltage signal is set to maximum. It is factory set for maximum rated speed.

To calibrate, set the MAX trimpot to full CCW, or voltage signal to maximum. Turn the main speed adjust potentiometer to full CW. Adjust the MAX trimpot until the desired maximum motor speed is reached. See Figure 20 for MAX trimpot location.

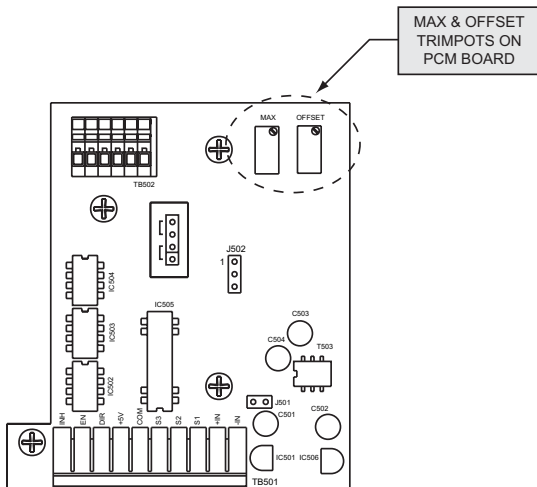

Figure 20. PCM Calibration Trimpot Locations

OFFSET (-PCM isolation card)



Warning

This trimpot is set at the factory and should not need adjustment. Do not adjust this trimpot unless you are experiencing drift problems. Contact your Minarik representative before attempting adjustment.

The RG60U-PCM has a factory-set offset to guarantee stability in a stopped motor. To calibrate the OFFSET trimpot:

1. Ensure that the input power is turned OFF.
2. Set the input signal to zero.
3. Set the OFFSET trimpot to the approximate midrange or 50%.
Note: This is a 25-turn potentiometer. After setting the trimpot to zero full CCW, make 5 full rotations to reach midrange, or 50%.
4. Apply power and observe the motor.
5. If the motor shaft drifts, or slowly rotates with no signal applied, adjust the OFFSET trimpot until the motor shaft stops. The direction and amount of trimpot adjustment depends on the direction of the shaft rotation and connection of the motor leads.

See Figure 20 on page 40 for OFFSET trimpot location.

Application Notes

Connections to Minarik DLC600

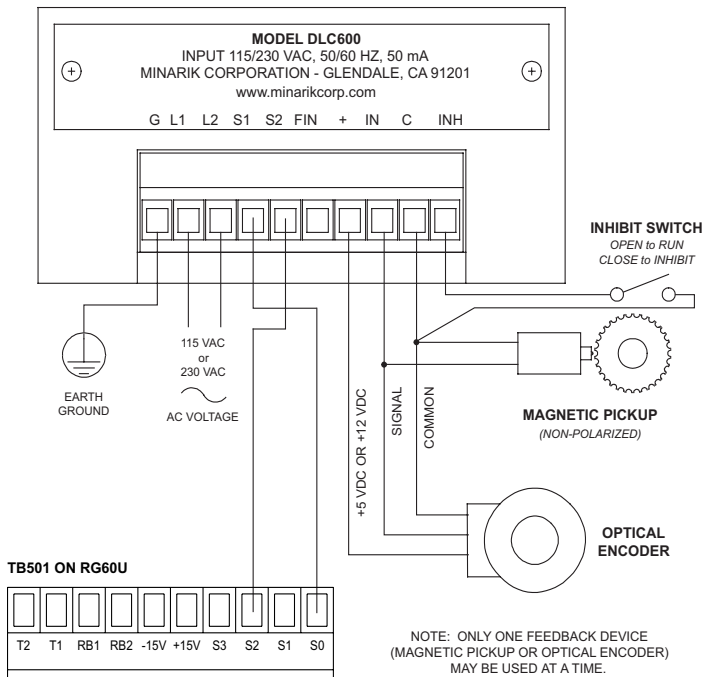

Figure 21. RG60U Connections to DLC600

FWD-REV switch

Use a single-pole, two-position switch with a single speed adjust potentiometer to plug reverse the motor (Figure 22).

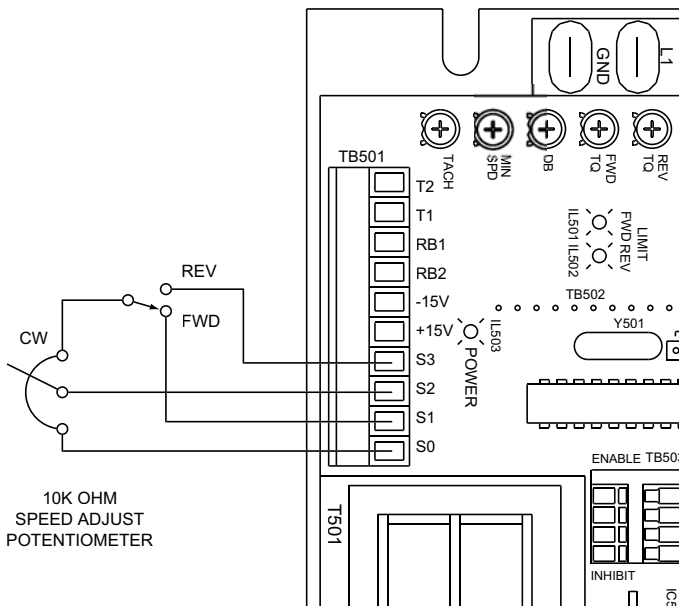

Figure 22. Forward-Reverse Switch

FWD-STOP-REV switch

Use a single-pole, three-position switch with a single speed adjust potentiometer to stop a motor between reversal (Figure 23). Set the switch to the center position to decelerate the motor to a stop.

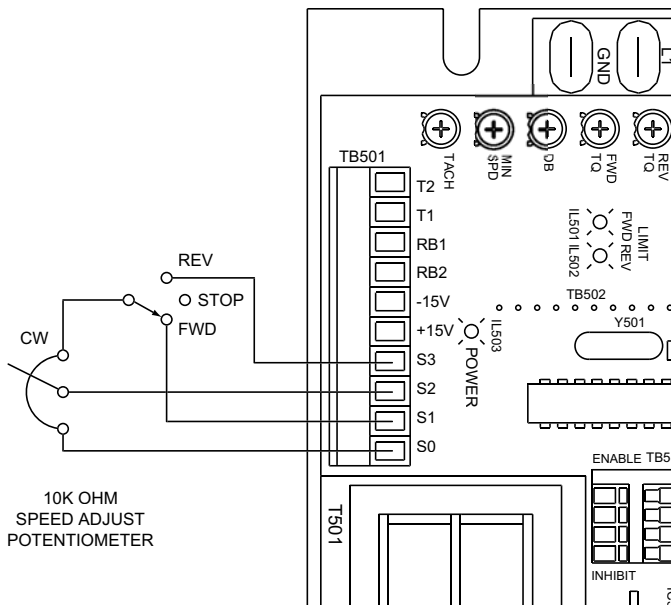

Figure 23. Forward-Stop-Reverse Switch

Independent Adjustable Speeds

Connect two speed adjust potentiometers with a single-pole, two position switch to select between two independent speeds shown in the forward direction (Figure 24). The speed adjust potentiometers can be mounted at two separate operating stations. Total parallel resistance must equal 10 kohms.

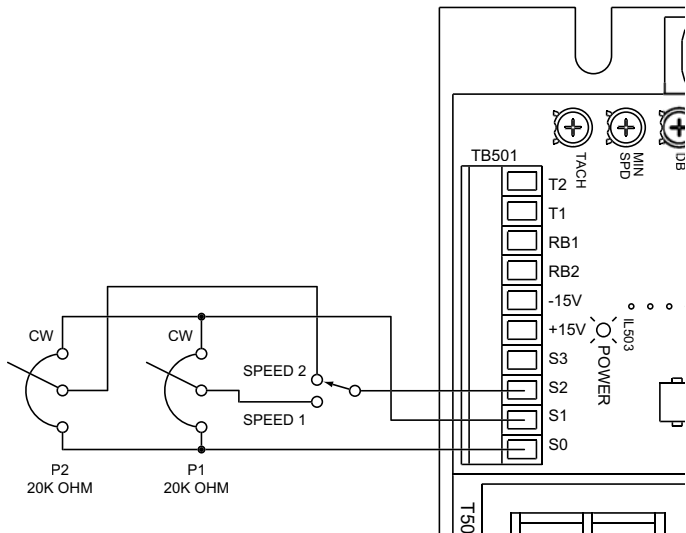

Figure 24. Independent Adjustable Speeds (Forward Direction)

Independent forward and reverse speeds

Connect two speed adjust potentiometers as shown in Figure 25 to select between independent forward and reverse speeds.

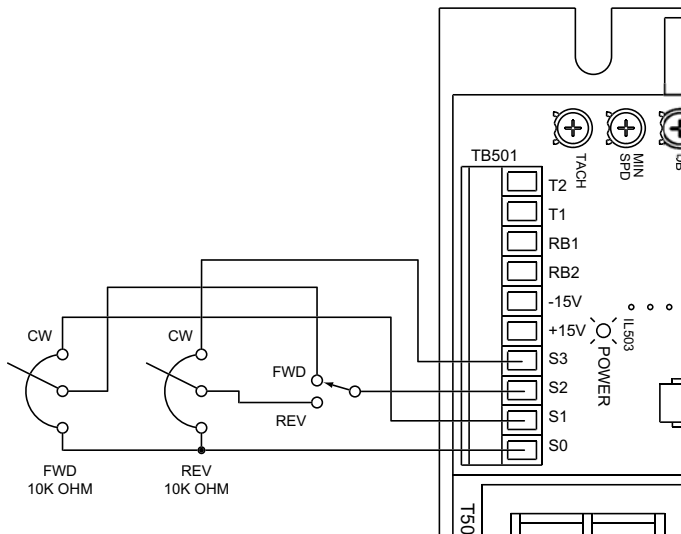

Figure 25. Independent Forward and Reverse Speeds

Independent forward and reverse speeds with FWD-STOP-REV switch

Use a single-pole, three-position switch to stop the motor when the switch is in the center position (Figure 26).

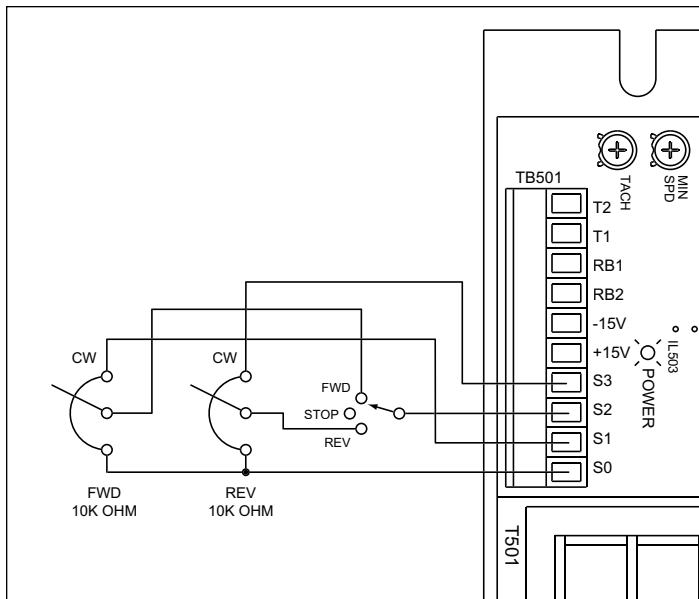

Figure 26. Independent Forward and Reverse Speeds with a Forward-Stop-Reverse Switch

Troubleshooting



Warning

Dangerous voltages exist on the drive when it is powered. When possible, disconnect the drive while troubleshooting. High voltages can cause serious or fatal injury.

Before applying power

Check the following steps before proceeding:

1. The AC line voltage must be connected to the proper terminals.
2. Check that the voltage switches and jumpers are set correctly.
3. The motor must be rated for the drive's rated armature voltage and current.
4. Check that all terminal block connections are correct.

For additional assistance, contact your local Minarik distributor, or the factory direct:

1-800-MINARIK (646-2745) or Fax: 1-800-394-6334

Problem	Possible Causes	Suggested Solutions
<p>Line fuse blows.</p>	<ol style="list-style-type: none"> 1. Line fuse is the wrong size. 2. Motor cable or armature is shorted to ground. 3. Nuisance tripping caused by a combination of ambient conditions and high-current spikes (i.e. reversing). 	<ol style="list-style-type: none"> 1. Check that the line fuse is correct for the motor size. 2. Check motor cable and armature for shorts. 3. Add a blower to cool the drive components; decrease FWD TQ and REV TQ settings, or resize motor and drive for actual load demand, or check for incorrectly aligned mechanical components or "jams".

Problem	Possible Causes	Suggested Solutions
Line fuse does not blow, but the motor does not run.	<ol style="list-style-type: none">1. Speed adjust potentiometer or speed reference voltage is set to zero speed.2. Speed adjust potentiometer or speed reference voltage is not connected to drive input properly; connections are open.3. INHIBIT terminals are shorted.4. S2 is shorted to S0.5. Drive is in current limit.6. Drive is not receiving AC line voltage.7. Motor is not connected.	<ol style="list-style-type: none">1. Increase the speed adjust potentiometer setting or speed reference voltage.2. Check connections to input. Verify that connections are not open.3. Remove the short from the INHIBIT terminals.4. Remove short.5. Verify that motor is not jammed. Increase FWD TQ or REV TQ setting if they are set too low.6. Apply AC line voltage to L1 and L2.7. Connect motor to A1 and A2.

Problem	Possible Causes	Suggested Solutions
Motor runs too fast.	MAX SPD not calibrated.	Calibrate MAX SPD.
Motor will not reach the desired speed.	<ol style="list-style-type: none"> 1. MAX SPD setting is too low. 2. IR COMP setting is too low. 3. Motor is overloaded. 4. Drive is in current limit. 	<ol style="list-style-type: none"> 1. Increase MAX SPD setting. 2. Increase IR COMP setting. 3. Check motor load. Resize the motor if necessary. 4. Verify torque settings.
Motor pulsates or surges under load.	<ol style="list-style-type: none"> 1. IR COMP is set too high. 2. Motor bouncing in and out of current limit. 	<ol style="list-style-type: none"> 1. Adjust the IR COMP setting slightly CCW until the motor speed stabilizes. 2. Make sure motor is not undersized for load; adjust FWD TQ and REV TQ trimpot CW.

Replacement Parts

Replacement parts are available from Minarik Corporation and its distributors for this drive series.

Table 2. Replacement Parts

Model No.	Symbol	Description	Minarik P/N
RG60U, RG61U	SCR501-508	800 V, 25 A SCR	072-0067
	T501	DST-336 Transformer	230-0104
		10K Ohm Potentiometer Kit	202-0104
		2-Pin Jumper	164-0292
Fuse Kits		3-8A Fuse Kit	050-0069
		5-20A Fuse Kit	050-0073

NOTES

NOTES

Unconditional Warranty

A. Warranty - Minarik Drives warrants that its products will be free from defects in workmanship and material for twelve (12) months or 3,000 hours, whichever comes first, from date of manufacture thereof. Within this warranty period, Minarik Drives will repair or replace, at its sole discretion, such products that are returned to Minarik Drives, 14300 De La Tour Drive, South Beloit, IL 61080-3006 USA.

This warranty applies only to standard catalog products, and does not apply to specials. Any returns for special controls will be evaluated on a case-by-case basis. Minarik Drives is not responsible for removal, installation, or any other incidental expenses incurred in shipping the product to and from the repair point.

B. Disclaimer - The provisions of Paragraph A are Minarik Drives sole obligation and exclude all other warranties of merchantability for use, express or implied. Minarik Drives further disclaims any responsibility whatsoever to the customer or to any other person for injury to the person or damage or loss of property of value caused by any product that has been subject to misuse, negligence, or accident, or misapplied or modified by unauthorized persons or improperly installed.

C. Limitations of Liability - In the event of any claim for breach of any of Minarik Drives obligations, whether express or implied, and particularly of any other claim or breach of warranty contained in Paragraph A, or of any other warranties, express or implied, or claim of liability that might, despite Paragraph B, be decided against Minarik Drives by lawful authority, Minarik Drives shall under no circumstances be liable for any consequential damages, losses, or expense arising in connection with the use of, or inability to use, Minarik Drives product for any purpose whatsoever.

An adjustment made under warranty does not void the warranty, nor does it imply an extension of the original 12-month warranty period. Products serviced and/or parts replaced on a no-charge basis during the warranty period carry the unexpired portion of the original warranty only.

If for any reason any of the foregoing provisions shall be ineffective, Minarik Drives liability for damages arising out of its manufacture or sale of equipment, or use thereof, whether such liability is based on warranty, contract, negligence, strict liability in tort, or otherwise, shall not in any event exceed the full purchase price of such equipment.

Any action against Minarik Drives based upon any liability or obligation arising hereunder or under any law applicable to the sale of equipment or the use thereof, must be commenced within one year after the cause of such action arises.



14300 De La Tour Drive, South Beloit, IL 61080

Phone: 1-800-MINARIK (646-2745)

Fax: (815) 624-6960

www.minarikdrives.com

Document Number 250-0324, Rev. 6

Printed in the U.S.A – 11/09